

# **AAHHi**

## **Portable Two Way Radio**



### **A46**

# **User Manual**

# **Welcome!**

Congratulations on your purchase of our instant communication equipment. Our products will provide you with high quality, clear voice, reliable and easy to use bidirectional person-to-person voice communication for your safety and improving efficiency.

Our products will keep you in constant touch with your team members for years to come with negligible maintenance down-time.

Please take a few minutes to read this manual carefully. The information presented here will allow you to derive maximum performance from your radio, in case questions arise later on.

# CONTENT

<b>SAFETY AND GENERAL INFORMATION</b> .....	<b>1</b>
<b>UNPACKING AND CHECKING EQUIPMENT</b> .....	<b>8</b>
Accessories List .....	错误! 未定义书签。
<b>PREPARATION</b> .....	<b>8</b>
Charging the Battery Pack .....	9
Installing/Removing the Battery Pack.....	9
Installing/Removing the Antenna.....	9
Attaching/Removing the Belt Clip.....	10
Attaching/Removing the Optional Accessory .....	10
<b>GETTING ACQUAINTED</b> .....	<b>11</b>
Orientation .....	11
Display Screen Guide .....	12
Working Band.....	14
Keypad Description.....	15

Programmable Auxiliary Functions.....	16
LED Indicator .....	17
<b>BASIC OPERATIONS.....</b>	<b>18</b>
Turn the Power On or Off.....	18
Adjusting the Volume .....	18
Selecting a Channel .....	18
Transmitting .....	19
Receiving .....	19
<b>MENU.....</b>	<b>20</b>
Menu Access.....	20
<b>Table 1 - 50 CTCSS Tones Table(Hz) .....</b>	<b>29</b>
<b>Table 2 - 105 DCS Codes Table .....</b>	<b>29</b>
<b>TROUBLESHOOTING GUIDE.....</b>	<b>30</b>
<b>EXCLUSIONS FROM WARRANTY COVERAGE .....</b>	<b>31</b>

# SAFETY AND GENERAL INFORMATION

Important Information on Safe and Efficient Operation, Read This Information Before Using Your Radio.

The information provided in this document supersedes the general safety information contained in user guides published before.

## **Transmit and Receive Procedure**

Your two-way radio contains a transmitter and a receiver .To control your exposure and ensures compliance with the occupational/controlled environment exposure limits, always adhere to the following procedure:

- ◆ Transmit no more than 50% of the time,
- ◆ To transmit, please press the Push to Talk (PTT) button.
- ◆ To receive calls, release the PTT button.

Transmitting 50% of the time, or less, is important because the radio generates measurable RF energy exposure only when transmitting (in terms of measuring standards compliance) .

## **Portable Radio Operation and EME Exposure**

### **Antenna Care**

Use only the supplied or the approved antenna for replacement. **DO NOT** hold the antenna when the radio is "IN USE". Holding the antenna affects the effective range.

### **Two-Way Radio Operation**

When using your radio as a traditional two way radio, hold the radio in a vertical position with the microphone 1 to 2 inches (2.5 to 5 cm) away from the lips.

### **Body-Worn Operation**

If you wear a radio on your body when transmitting, always place the radio in our supplied or approved clip, holder, holster, case, or body harness for this product.

If you do not use our supplied or approved body-worn accessories, and are not using the radio held in the normal use position, ensure the radio and its antenna are at least 1 inch (2.5 cm) from your body when transmitting.

### **Data Operation**

If applicable, when using any data feature of the radio with or without an accessory cable, position the radio and its antenna at least 1 inch (2.5cm) from the body.

### **Electromagnetic interference/Compatibility**

**NOTE:**Nearly every electronic device is susceptible to electromagnetic interference (EM) if inadequately shielded, designed, or otherwise configured for electromagnetic compatibility.

## **Facilities**

To avoid electromagnetic interference and /or compatibility conflicts, turn off your radio in any facility where posted notices instruct you to do so. Hospitals or health care facilities may be using equipment that is sensitive to external RF energy.

## **Aircraft**

When instructed to do so, turn off your radio when on board an aircraft .Any use of a radio must be in accordance with applicable regulations per airline crew instructions.

## **Medical Devices**

### **Pacemakers**

The Advanced Medical Technology Association recommends that a minimum separation of 6 inches (15 cm) be maintained between a handheld wireless radio and pacemaker .These recommendations are consistent with the independent research by and recommendations of the U.S. Food and Drug Administration.

### **Persons with pacemakers should:**

- ◆ **ALWAYS** keep the radio more than six inches (15cm) from their pacemaker when the radio is turned ON.
- ◆ Not carry the radio in the breast pocket.
- ◆ Use the ear opposite the pacemaker to minimize the potentiality for interference.
- ◆ Turn the radio OFF immediately if you have any reason to suspect that interference is

taking place.

### **Hearing Aids**

Some digital wireless radios may interfere with some hearing aids. In the event of such interference, you may want to consult your hearing aid manufacturer to discuss alternatives.

### **Other Medical Devices**

If you use any other personal medical device, consult the manufacturer of your device to determine if it is adequately shielded from RF energy. Your physician may be able to assist you in obtaining this information.

### **Safety and General Use While Driving**

Check the laws and regulations on the use of radios in the area where you drive. Always obey them. When using your radio while driving, please:

- ◆ Give full attention to driving and to the road,
- ◆ Use hands-free operation, if available.
- ◆ Pull off the road and park before making or answering a call if driving conditions so required.

## Operational Warnings



### Warnings

#### ◆ For Vehicles with an Air Bag

Do not place a portable radio in the area over an air bag or in the air bag deployment area. Air bags inflate with great forces. If a portable radio is placed in the air bag deployment area and the air bag inflates, the radio may be propelled with great force and cause serious injury to occupants of the vehicle.

#### ◆ Potentially Explosive Atmospheres

Turn off your radio prior to entering any area with a potentially explosive atmosphere, unless it is a radio type especially qualified for use in such areas as “Intrinsically Safe”. Do not remove, install, or charge batteries in such areas. Sparks in a potentially explosive atmosphere can cause an explosion or fire resulting in bodily injury or even death.

Note: The areas with potentially explosive atmosphere referred above include fueling areas such as below decks on boats, fuel or chemical transfer or storage facilities, areas where the air contains chemicals or particles, such as grain, dust or metal powders, and any other area where you would normally be advised to turn off your vehicle engine. Areas with potentially explosive atmosphere are often but not always posted.

#### ◆ Blasting caps and Areas

To avoid possible interference with blasting operations, turn off your radio when you are near electrical blasting caps, in a blasting area, or in area posted;”Turn off two-way radio. Obey all signs and instructions.

## **Operational Cautions**

### **Antenna**

Do not use any portable radio that has a damaged antenna. If a damaged antenna comes into contact with your skin, a minor burn can result.

### **Batteries**

All batteries can cause property damage and/or bodily injury such as burns if a conductive material such as jewelry, keys, or beaded chains touches exposed terminals. The conductive material may complete an electrical circle (short circuit) and become quite hot. Exercise care in handling any charge battery, particularly when placing it inside a pocket, purse, or other container with meal objects.

### **Battery Charger Safety Instructions**

1. Do not expose the charger to rain or snow.
2. Do not operate or disassemble the charger if it has received a sharp blow, or has been dropped or damage in any way.
3. Never after the AC cord or plug provide with the unit .If the plug will not fit the outlet, have the proper outlet installed by a qualified electrician. An improper condition can result in a risk of electric shock.
4. To reduce the risk of damage to the cord or plug, pull the plug rather than the cord when disconnecting the charger from the AC receptacle.
5. To reduce the risk of electric shock, unplug the charger from the outlet before attempting any maintenance or cleaning.

6. Use of an attachment not recommended or sold by us may result in a risk of fire, electric shock ,or personal injury.
7. Make sure the cord is located so it will not be stepped on, tripped over ,or subjected to damage or stress.
8. An extension cord should not be used unless absolutely necessary. Use of an improper extension cord could result in a risk of fire and /or electric shock. If an extension cord must be used, make sure that:
  - ◆ The pins on the plug of the extension cord are the same number, size, and shape as those on the plug of the charger.
  - ◆ The extension cord is properly wired and in good electrical condition.
9. The supply cord of this charger can not be replaced.

# UNPACKING AND CHECKING EQUIPMENT

Carefully unpack the radio. We recommend that you identify the items listed in the following table before discarding the packing material. If any items are missing or have been damaged during shipment, file a claim with the carrier immediately.

## Accessories List



Antenna



Li-ion Battery



Belt Clip

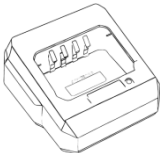

Charger



Adapter

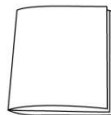

User Manual

## PREPARATION

### Charging the Battery Pack

1. Place the charger on a flat surface.
2. Insert the plug of the power cord into the jack on the charger.
3. Plug the cord into an AC outlet.
4. Insert the radio which with battery installed (Make sure turn the radio off before charging.) or individual battery pack into the charging slot.
5. It takes around 5 hours to charge till the battery is fully charged.

**Note:** Please charge the battery only with the approved charger, power supply, charging cable ect.. Initially charging the battery pack after purchase or extended storage (greater than 2 months) will not bring the battery pack to its normal operating capacity. After repeating the charge/discharge cycle two or three times, the operating capacity will increase to normal level.

### Installing/Removing the Battery Pack

1. Align the convex part on the top of the battery with the groove of the chassis and insert it, then press the bottom of the battery and lift up the battery latch and press to fasten it.
2. Turn off the power, pull the battery latch outward and then remove the battery pack.

### Installing/Removing the Antenna

1. Put the antenna on the connector and rotate the antenna clockwise till hand tight.
2. Rotate the antenna counter clockwise till you can remove it.

### **Attaching/Removing the Belt Clip**

- 1.Align the rails on the belt clip with the grooves on the battery, then press the belt clip downwards into place.
- 2.To remove the belt clip, hook the clip latch upwards and then push the belt clip forward out of the slide groove to remove the belt clip.

### **Attaching/Removing the Optional Accessory**

- 1.Open(no remove) the accessory jack cover, then plug the accessory firmly into the jack.
- 2.To remove, pull the accessory and put the cover back in right position.

# GETTING ACQUAINTED



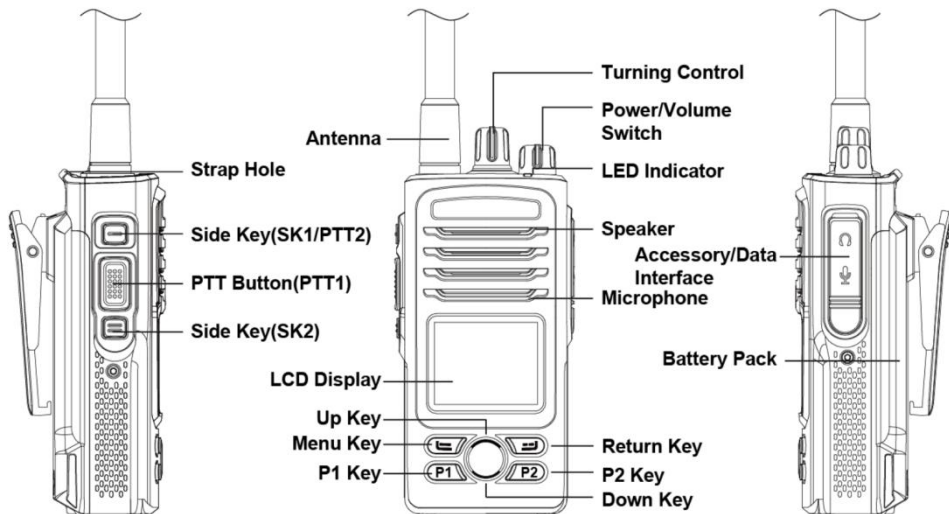



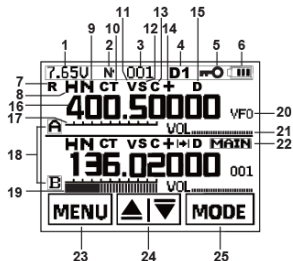









## Orientation



## Display Screen Guide



No.	Icon	Explanation
1	7.65V	Current Battery Voltage
	FM 100.7	FM Radio Frequency
2	N	Noise Reduction(paid feature)
3	001	ANI
4	D1	Digital Service Group
5	K	Keypad Lock
6	Battery icon	Battery Meter
7	R	Reverse Frequency
8	H or L	High or Low Output Power
9	W or N	Wide or Narrow Bandwidth

No.	Icon	Explanation
10	 or 	CTCSS/DCS
	DP	Digital Service
11		Hands-Free VOX
12		Scrambler
13		Comandor
14	 or 	Positive (+) or Negative (-) Offset Direction
15	<b>D</b>	DTMF
	<b>T</b>	2-Tone
16	<b>400.50000</b>	Frequency/Channel Name/Menu
17		Standby for Signal
18	 or 	A or B Working Band
19		 :Low Power
		 :High Power
20	VFO/001	VFO mode or Numbers of Channels in MR/CH/NM Mode
21	<b>VOL.</b> 	Receiving Voice
22		Main Working Band
23	<b>MENU</b>	Menu Access or Confirmation of Selection
24		Up and Down
25	<b>MODE</b>	Change Working Mode or Exit/Return Previous Menu

**Note:** When in the menu system, it will automatically exit the menu after 10s of no operation.

## Working Band

There are two main working bands, choose the correct working band is essential in order to operate smoothly.

### ■ Change Main Working Band

In standby mode, press [P2] key to change Band A and Band B.

-  will appear on LCD display and show you the current main working band.

### ■ Change Working Mode

In standby mode, press [] key circularly to change between VFO,MR,CH mode.



VFO mode













MR mode



CH mode

### ■ Dual Work

In order to dual display A & B band and monitor dual frequency or channels, you can turn on this function.

1. In standby mode, press [] key to access menu system.
2. Use []/[] key to select “**System Config**” and press [] key to access sub menu system.
3. Use []/[] key again to select “**14 Double Work**” and press [] key to access setting mode.
4. Use []/[] key to select “**Close**” or “**Open**” and press [] key to confirm your selection.
5. Press [PTT] button to exit the menu setting mode.

## Keypad Description

Key	What You Operate
[↵]	1) In standby mode, press [↵] key to access menu system. 2) In menu system, press [↵] key to confirm your selection.
[↶]	1) In standby mode, press [↶] key to change the radio working mode between VFO and MR/CH/NM modes. 2) In menu system, press [↶] key to exit the current menu and return to the superior menu until exiting the menu system.
[↷]	In standby mode, press [↷] key to select an operating channel, menu value or others.
[↸]	In standby mode, press [↸] key to select an operating channel, menu value or others.
[P1]	1) In standby mode, press and hold [P1] key for 3 seconds to lock or unlock the keypad. 2) In "Channel Set" menu, when select CTCSS/DCS, press [P1] key to toggle between CTCSS tone, DCS normal code and DCS inverted code. 3) When turn on "Call Tone" function, in standby mode, press [P1] key to transmit a call.
[P2]	1) In standby mode, press [P2] key to change main working band. 2) In standby mode, press [P2] key to select output power between High and Low Level.

## Programmable Auxiliary Functions

Your dealer may program the [SK1], [SK2], [P1] or [P2] key (long press or short press) with one of the following auxiliary functions respectively.

No.	Function	No.	Function
0	Off	10	Battery Electric Power Display
1	Scan	11	Key Lock
2	VOX	12	Scramble Switch
3	Squelch Off	13	Channel Group Switch
4	*Squelch Off Momentary	14	Noise Reduction (Paid Feature)
5	Adjust Power Level	15	Call Tone
6	Emergency Alarm	16	1750Hz
7	Annunciation CH No.	17	Dial List
8	Roger	18	NOAA
9	Screen Display	19	PTT Function

### Note:

- You can set the time of pressing long key from 0.3-10 seconds(default: 2 seconds) with programming software, when you press anyone of [SK1], [SK2], [P1] or [P2] key, the time of pressing is over your setting time, then it's a long time key, otherwise, it's a short key.
- For marked item with (\*), this function is only to be programmed when it's a long key.

## LED Indicator



LED Indicator	Radio Status
Glowes red	Transmitting
Flashes red	Low Battery Alert
Glowes green	Receiving
Flashes green	Scanning



LED Indicator	Charging Status
Glowes red	The battery is being charged.
Glowes green	The battery has been charged completely.
Flashes red rapidly	The battery fails to be charged.

## BASIC OPERATIONS

### Turn the Power On or Off

Turn the [**Power/Volume Knob**] clockwise to turn the radio ON.

- *The display screen then shows the current channels, code and all features that are enabled. The radio is now in two-way mode.*

Turn the [**Power/Volume Knob**] counter clockwise to turn the radio OFF.

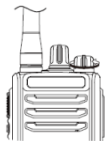

### Adjusting the Volume



Rotate the [**Power/Volume Knob**] to adjust the volume.

Clockwise increases the volume and counter clockwise decreases it. You may need to adjust the volume more precisely while communicating with other parties.

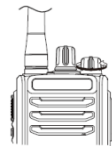
- *Do not hold the radio close to your ear. If the volume is set to an uncomfortable level, it could hurt your ear.*



### Selecting a Channel

Rotate the [**Tuning Control**] or use []/[] key to select your desired channel.

- *When a non-programmed channel is selected, an alert tone sounds will be heard.*



## Transmitting

To communicate, all radios should be in the same channel/frequency and signaling & encryption (CTCSS tone, DCS code, AEC ect.).

- *An analog channel can't communicate with a digital channel.*

1. To talk, press and hold **[PTT]** button and speak

- *For best sound quality at the receiving station, hold the microphone approximately 1.5 inches (3~6 cm) from your mouth.*

2. Release the **[PTT]** button to standby.

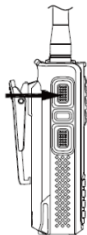

## Receiving

Your dealer may have programmed CTCSS/DCS, Scrambler signaling ect. in your radio.

If your selected channel is programmed with one of these features, you will hear calls only when another party in your system transmits which has the same signaling with yours. All other calls will not be heard.

If your selected channel is not set up with a signaling type, you will hear calls made by any party (not just those in your system).

# MENU

## Menu Access

1. In standby mode, press [M] key to access menu system.

• *The menu list appears.*



2. Use [←]/[→] key to select the desired main menu.

3. Press [M] key to enter sub menu setting mode.

4. Then use [←]/[→] key again to select the desired sub menu number.

5. Press [M] key to enter setting mode.

6. Use [←]/[→] key to switch ON/OFF or select numeric values.

7. Press [M] key to complete the setting.

• *You can press [M] key to turn back previous menu till exit menu system.*

8. Press [PTT] button to exit menu system.

### **Note:**

*In this manual, when you enter and use menu system to select, Please make sure the operation in 10 seconds after pressing [M] key. Otherwise, the radio will turn back to original working mode.*

Main Menu	Sub Menu No.	Selectable	Explanation
Device Info	01 Radio Name	User 0-User 250	Edited by programming software.
	02 Device Info	Soft Version Program Time	This info is automatically recorded and generated by the programming software, it cannot be changed.
	03 Embedded Info	---	Assigned by programming software.
Channel Set	01 Power	Low Power High Power	Low Power: Less power consumption, but shorter call distance High Power: Longer call distance but higher power consumption
	02 Band Set	Narrow Wide	Select narrow or wide band.
	03 VOX	Close Open	Turn on or off VOX function.
	04 VOX Level	Close, 1-10	1: the highest sensitivity level 9: the lowest sensitivity level
	05 Scramble	Close Open	Turn on or off scrambler function.
	06 Compand	Close Open	Turn on or off compandor function.
	07 Dec-CTDCS	000 Off ... 051 DCS-D023N ... 051 DCS-D023I ...	Access " <b>Dec-CTDCS</b> " menu, press [*] key to toggle next CTCSS/DCS group for selection.

	08 Enc-CTDCS	000 Off ... 051 DCS-D023N ... 051 DCS-D023I ...	Access “ <b>Enc-CTDCS</b> ” menu, press [*] key to toggle next CTCSS/DCS group for selection.
	09 Step	0.05/0.25/2.5/5/6.25 /10/12.5/15/20/25/30 /50/100/500K	Select your desired frequency step.
	10 Sft	None - +	None: without any offset. +:Positive offset direction -:Negative offset direction
	11 Offset Freq	0.00000-450.00000	The combined frequency between offset frequency and radio's current working frequency must be in the range of your radio, if not, an error tone will sound when you press <b>PTT</b> .
	12 Rev Freq	Close Open	Turn on or off reverse function.
	13 Channel Save	---	Select your desired channel number to save.
	14 Channel Del	---	Select your desired channel number to delete.
	15 Channel Name	Close Open	Edited by programming software.
	16 Scan	---	Start scanning
	17 Scan Add/Del	Delete Add	Add or del scan
	18 NOAA	Close 1-11	Turn on or off NOAA weather alert.

Key Functions	01 SK1 Key Short	Close	<b>Squelch Mom</b> for long key only, other items are available for both short key and long key.
	02 SK1 Key Long	Squelch Off	
	03 SK2 Key Short	Squelch Mom VOX	
	04 SK2 Key Long	Adjust Power	
	05 P1 Short	Scan	
	06 P1 Long	Roger	
	07 P2 Short	Screen Show	
	08 P2 Long	Bat Power Alarm Channel No CH Group Scramble Send 1750Hz Dial List Noise Cancel Key Lock Call Tone PTT Func NOAA	
	09 Key Lock Mode	Manual Auto 5s/10s/20s/30s Auto 5s/10s/20s/30s Save	Set key lock mode.

Quick Teaming	01 Quick Team T	---	Display “ <b>Quick Team TX, Quick Teaming, Please Wait...</b> ”
	02 Quick Team R	---	Display “ <b>Quick Team RX, Quick Teaming, Please Wait...</b> ”
	03 Gen. CH[PTT]	---	<p>This feature will randomly generate at most 32 channels.</p> <ol style="list-style-type: none"> <li>1. Turn off the power firstly.</li> <li>2. Then press and hold [PTT1] or [PTT2], turn on the power.</li> <li>3. Release PTT and access “<b>03 Gen. CH[PTT]</b>” menu.</li> <li>4. Use [↶]/[↷] key to select your desired channel quantity.</li> <li>5. Press [↵] key to confirm.</li> <li>6. Press [↶] key to exit menu system and finish, then you can use these channels.</li> </ol>
	04 Freq Measure	---	<ol style="list-style-type: none"> <li>1. Access “<b>04 Freq Measure</b>” menu.</li> <li>2. Use [↶]/[↷] key to select your desired channel number to save.</li> <li>3. Press the other radio PTT to transmit</li> </ol>

			<p>which the closer the better.</p> <p>4. When frequency to be showed on LCD, it means already successfully measure and save in your select channel number in step 2.</p> <p>5. Press [←] key to measure and save for next one.</p> <p>6. At last, press [→] key to exit this function.</p>
Signaling Set	01 Signal Type	None DTMF 2Tone/5Tone	Select signal type.
	02 PTT ID Set	Close BOT EOT BOTH	<p>You can decide when sending the PTT-ID code in transmitting mode.</p> <ul style="list-style-type: none"> <li>• Close: press PTT without sending the PTT-ID.</li> <li>• BOT: the code will be sent when you press the PTT.</li> <li>• EOT: the code will be sent when the PTT is released.</li> <li>• BOTH: the code will be sent when you press and release the PTT.</li> </ul>

Digital Service	01 Digit Serve	Close Open	Turn on or off digital service function.
	02 Call Sort	Single Call Group Call All Call	Select call type.
	03 Member Sel	User 0-User 250	Edited by programming software.
	04 Group Sel	Group 0-Group 9 Priority G	Edited by programming software.
Attachment Set	01 Radio	Close Open	This is an optional paid feature, you can turn on or off FM broadcast function.
System Config	01 Language	English Chinese	Choose the language of voice prompt.
	02 Beep	Close Open	Turn on or off keypad tone.
	03 Backlight	Open Auto 5s/10s/20s/30s/60s	Open: always light on. Auto: automatically light off after pre-set time.
	04 Boot Screen	Picture Voltage Information	Edited by programming software.

	05 Wait Light	Close Open	Turn on or off LED indicator when standby.
	06 Save Mode	Close 1:1 1:2 1:3 1:4 1:5	Close: turn off battery saver. 1:1: The least energy-efficient, but with shorter delay time. 1:5: The most energy-efficient, but with longer delay time.
	07 CH Group	Group A Group B	Select channel group.
	08 Work Mode A	Freq. Mode CH-VFO Mode Channel Mode	Select working mode in A band.
	09 Work Mode B	Freq. Mode CH-VFO Mode Channel Mode	Select working mode in B band.
	10 TOT	Close 15s/30s/45s/60s/75s/90s/105s/120s/135s/150s/165s/180s/195s/210s/225s/240s/255s/270s	Set Time-Out Timer.
	11 SQL	0-9	0: the lowest level 9: the highest level

	12 Power On Tone	Close Tone 1-7	Select power on tone.
	13 Roger	Close Open	Turn on or off roger function.
	14 Voice Sort	Close English	Select the language of voice prompt.
	15 Double Work	Close Open	Set dual band/display/monitor.
	16 Call Tone	Close 1-10	Select call tone.
	17 Display Type	Night Mode Daytime Mode	Choose different LCD backlight colors to better suit the use environment.
	18 Reset	Config Reset Clear Channel Factory Preset	Reset the radio.
	19 Noise Cancel	Close Open	Turn on or off noise reduction feature for a clear voice.

## Table 1 - 50 CTCSS Tones Table(Hz)

67.0	79.7	94.8	110.9	131.8	156.7	171.3	186.2	203.5	229.1
69.3	82.5	97.4	114.8	136.5	159.8	173.8	189.9	206.5	233.6
71.9	85.4	100.0	118.8	141.3	162.2	177.3	192.8	210.7	241.8
74.4	88.5	103.5	123	146.2	165.5	179.9	196.6	218.1	250.3
77.0	91.5	107.2	127.3	151.4	167.9	183.5	199.5	225.7	254.1

## Table 2 - 105 DCS Codes Table

023	065	132	205	255	331	413	465	612	723
025	071	134	212	261	332	423	466	624	731
026	072	143	223	263	343	431	503	627	732
031	073	145	225	265	346	432	506	631	734
032	074	152	226	266	351	445	516	632	743
036	114	155	243	271	356	446	523	645	754
043	115	156	244	274	364	452	526	654	
047	116	162	245	306	365	454	532	662	
051	122	165	246	311	371	455	546	664	
053	125	172	251	315	411	462	565	703	
054	131	174	252	325	412	464	606	712	

# TROUBLESHOOTING GUIDE

Phenomena	Analysis	Solution
You cannot turn on the radio.	The battery may be installed improperly.	Remove and reattach the battery.
	The battery power may run out or died.	Recharge or replace the battery.
	The battery may suffer from poor contact caused by dirty or damaged battery contacts.	Clean the battery contacts or replace the battery.
During receiving, the voice is weak or intermittent.	The battery voltage maybe low.	Recharge or replace the battery.
	The volume level may be low.	Increase the volume.
	The antenna maybe loose or maybe installed incorrectly.	Turnoff the radio, and then remove and reattach the antenna.
	The speaker maybe blocked.	Clean the surface of the speaker.
You cannot communicate with other group members.	The frequency or signaling type maybe inconsistent with that of other members.	Verify that your TX/RX frequency and signaling type are correct.
	You may be too far away from other members.	Move towards other members.
You hear unknown voices or noise.	You may be interrupted by radios using the same frequency.	Change the frequency, or adjust the squelch level.
	The radio in analog mode maybe set with no signaling.	Request your dealer to set signaling for the current channel to avoid interference.
You are unable to hear anyone because of too much noise and hiss.	You may be too far away from other members.	Move towards other members.
	You may be in an unfavorable position. For example, your communication may be blocked by high buildings or blocked in an underground area.	Move to an open and flat area, restart the radio, and try again.
	It may be the result of external disturbance (such as electromagnetic interference).	Stay away from equipment that may cause interference.
The radio keeps transmitting.	VOX may be turned on or the headset is not installed in place.	Turn off the VOX function. Check that the headphones are in place.

## **EXCLUSIONS FROM WARRANTY COVERAGE**

### **Normal Wear and Tear:**

Periodic maintenance, repair and replacement of products or accessories due to normal wear and tear.

### **Abuse & Misuse:**

Defects or damage that results from:

- a. improper operation, storage, misuse or abuse, accident or neglect, such as physical damage (cracks, scratches, etc.) to the surface of the products and accessories resulting from misuse;
- b. contact with liquid, water, rain, extreme humidity or heavy perspiration, sand, dirt or the like, extreme heat, or food;
- c. use of the products or accessories for commercial purposes or subjecting the product or accessory to abnormal usage of conditions;
- d. other acts which are not the fault of us.

### **Use of non our branded products and accessories:**

Defects or damage that result from the use of non our branded or certified products, accessories, software or other peripheral equipment.

### **Unauthorized Service or Modification:**

Defects or damages resulting from service, testing, adjustment, installation, maintenance, alteration, or modification in any way by someone other than us or our authorized party.

**Altered Products:**

Products or accessories with:

- a. serial numbers or date tags that have been removed, altered or obliterated;
- b. broken seals or that show evidence of tampering;
- c. mismatched board serial numbers;
- d. or nonconforming or non our branded housings, or parts.

**Communication Services:**

Defects, damages, or the failure of products or accessories due to any communication service or signal you may subscribe to or use with products or accessories.

For more relevant information, please visit our website ([www.aahhi.com](http://www.aahhi.com)) or contact us (E-mail:[info@aahhi.com](mailto:info@aahhi.com)).

# AAHHi



Quanzhou Aahhi Electronics Co., Ltd.  
www.aahhi.com

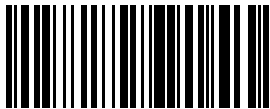

5 1 0 4 1 0 2 7 1

©Copyright 2023  
Quanzhou Aahhi Electronics Co., Ltd.  
All rights reserved.

No portion of this manual  
may be reproduced  
without the permission of  
Quanzhou Aahhi Electronics Co., Ltd.

Printed in China

**Note:**

**Features and Specifications are subject to change without notice. AAHHi is not responsible for unintentional errors or omissions on its packaging.**